

ACT108W-600E

AC Thyristor power switch

Rev. 03 — 21 October 2009

Product data sheet

1. Product profile

1.1 General description

AC Thyristor power switch in a SOT223 surface-mountable plastic package with self-protective capabilities against low and high energy transients

1.2 Features and benefits

- Common terminal on mounting base allows multiple ACTs on shared cooling pad
- Exclusive negative gate triggering
- Full cycle AC conduction
- Remote gate separates the gate driver from the effects of the load current
- Safe clamping of low energy over-voltage transients
- Self-protective turn-on during high energy voltage transients
- Surface-mountable package
- Very high noise immunity

1.3 Applications

- Contactors, circuit breakers, valves, dispensers and door locks
- Fan motor circuits
- Lower-power highly inductive, resistive and safety loads
- Pump motor circuits

1.4 Quick reference data

Table 1. Quick reference

Symbol	Parameter	Conditions	Min	Typ	Max	Unit
V_{DRM}	repetitive peak off-state voltage		-	-	600	V
I_{GT}	gate trigger current	$V_{\text{D}} = 12 \text{ V}$; $I_{\text{T}} = 100 \text{ mA}$; LD+ G-; $T_{\text{j}} = 25 \text{ }^{\circ}\text{C}$; see Figure 10	1	-	10	mA
		$V_{\text{D}} = 12 \text{ V}$; $I_{\text{T}} = 100 \text{ mA}$; LD- G-; $T_{\text{j}} = 25 \text{ }^{\circ}\text{C}$	1	-	10	mA
$I_{\text{T(RMS)}}$	RMS on-state current	full sine wave; $T_{\text{sp}} \leq 112 \text{ }^{\circ}\text{C}$; see Figure 3 , 1 and 2	-	-	0.8	A
dV_{D}/dt	rate of rise of off-state voltage	$V_{\text{DM}} = 402 \text{ V}$; $T_{\text{j}} = 125 \text{ }^{\circ}\text{C}$; gate open circuit; see Figure 14	1000	-	-	V/ μs

Table 1. Quick reference ...continued

Symbol	Parameter	Conditions	Min	Typ	Max	Unit
V_{CL}	clamping voltage	$I_{CL} = 100 \text{ mA}$; $t_p = 1 \text{ ms}$; $T_j \leq 125 \text{ }^\circ\text{C}$; see Figure 17	650	-	-	V
V_{PP}	peak pulse voltage	$T_j = 25 \text{ }^\circ\text{C}$; non-repetitive, off-state; see Figure 6	-	-	2	kV
V_T	on-state voltage	$I_T = 1.1 \text{ A}$; see Figure 13	-	-	1.3	V

2. Pinning information

Table 2. Pinning information

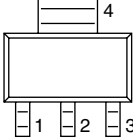
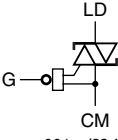
Pin	Symbol	Description	Simplified outline	Graphic symbol
1	LD	load	 <p>SOT223 (SC-73)</p>	 <p>001aa924</p>
2	CM	common		
3	G	gate		
mb	CM	mounting base; connected to common		

3. Ordering information

Table 3. Ordering information

Type number	Package		Version
	Name	Description	
ACT108W-600E	SC-73	plastic surface-mounted package with increased heatsink; 4 leads	SOT223

4. Limiting values

Table 4. Limiting values

In accordance with the Absolute Maximum Rating System (IEC 60134).

Symbol	Parameter	Conditions	Min	Max	Unit
V_{DRM}	repetitive peak off-state voltage		-	600	V
$I_{T(RMS)}$	RMS on-state current	full sine wave; $T_{sp} \leq 112\text{ }^{\circ}\text{C}$; see Figure 3, 1 and 2	-	0.8	A
I_{TSM}	non-repetitive peak on-state current	full sine wave; $T_{j(\text{init})} = 25\text{ }^{\circ}\text{C}$; $t_p = 16.7\text{ ms}$	-	8.8	A
		full sine wave; $T_{j(\text{init})} = 25\text{ }^{\circ}\text{C}$; $t_p = 20\text{ ms}$; see Figure 4 and 5	-	8	A
I^2t	I^2t for fusing	$t_p = 10\text{ ms}$; sin-wave pulse	-	0.32	A^2s
dl_T/dt	rate of rise of on-state current	$I_T = 1\text{ A}$; $I_G = 20\text{ mA}$; $dl_G/dt = 0.2\text{ A}/\mu\text{s}$	-	100	$\text{A}/\mu\text{s}$
I_{GM}	peak gate current	$t = 20\text{ }\mu\text{s}$	-	1	A
V_{GM}	peak gate voltage	positive applied gate voltage	-	15	V
$P_{G(AV)}$	average gate power	over any 20 ms period	-	0.1	W
T_{stg}	storage temperature		-40	150	$^{\circ}\text{C}$
T_j	junction temperature		-	125	$^{\circ}\text{C}$
V_{PP}	peak pulse voltage	$T_j = 25\text{ }^{\circ}\text{C}$; non-repetitive, off-state; see Figure 6	-	2	kV

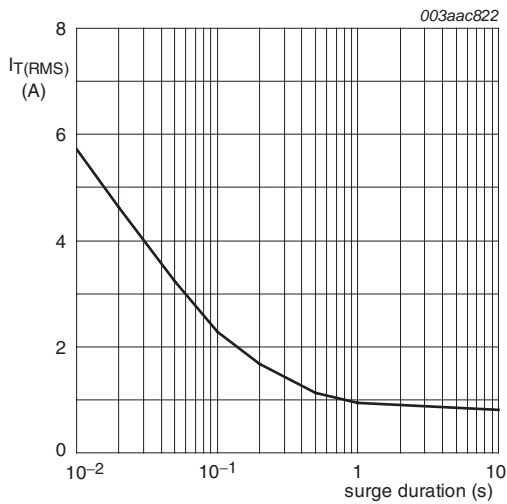

$f = 50\text{ Hz}$; $T_{sp} = 112\text{ }^{\circ}\text{C}$

Fig 1. RMS on-state current as a function of surge duration; maximum values

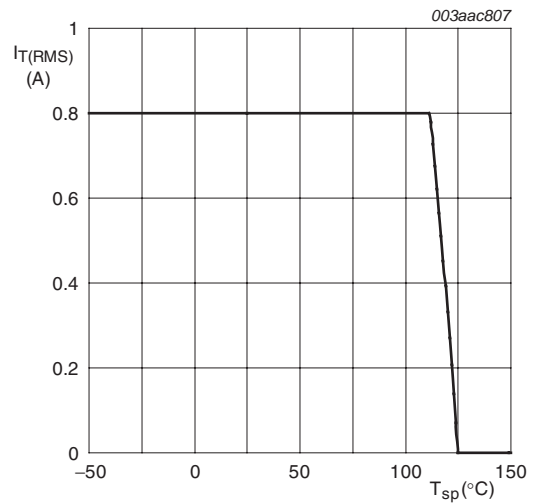

Fig 2. RMS on-state current as a function of solder point temperature; maximum values

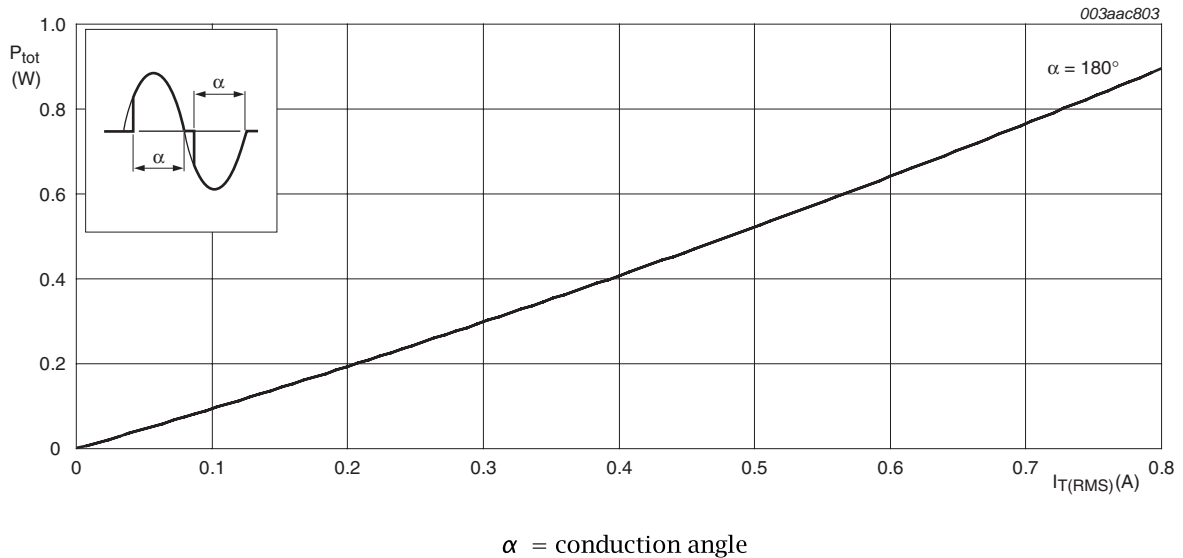

Fig 3. Total power dissipation as a function of RMS on-state current; maximum values

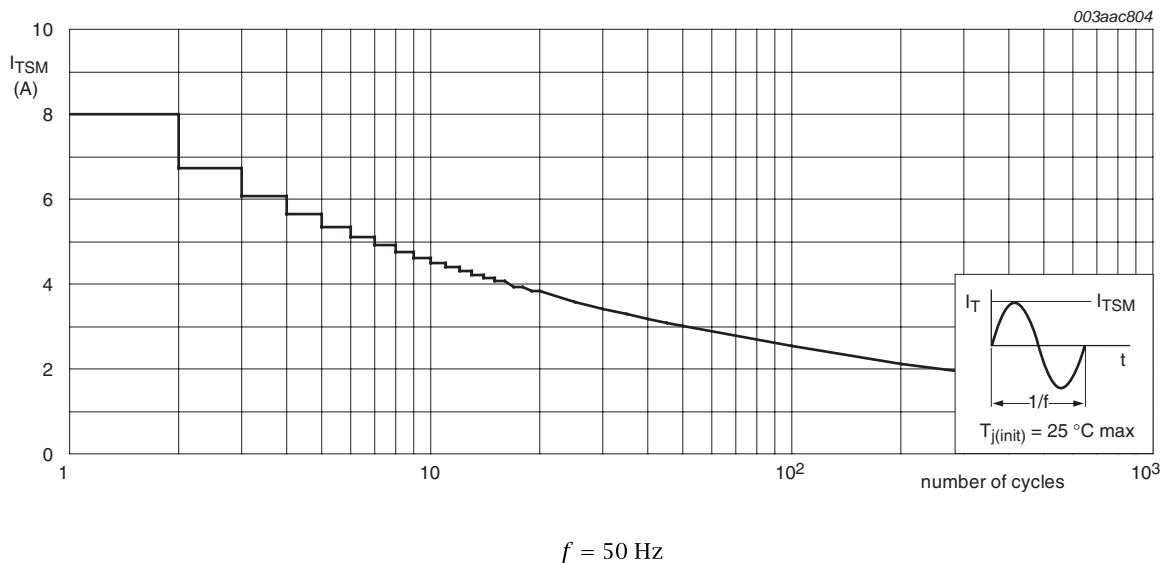
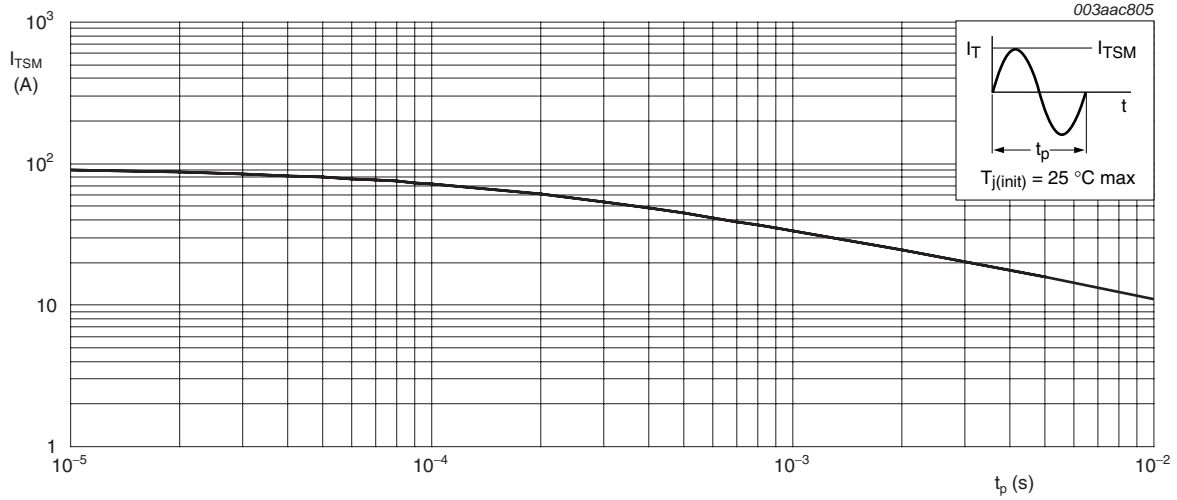

Fig 4. Non-repetitive peak on-state current as a function of the number of sinusoidal current cycles; maximum values



$t_p \leq 20\text{ ms}$

Fig 5. Non-repetitive peak on-state current as a function of pulse width; maximum values

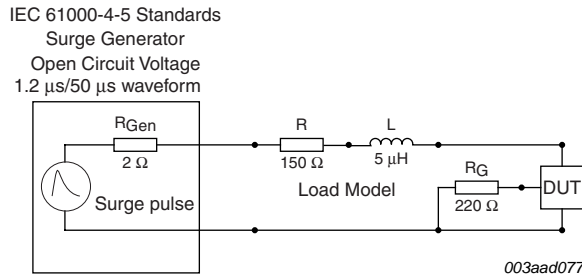
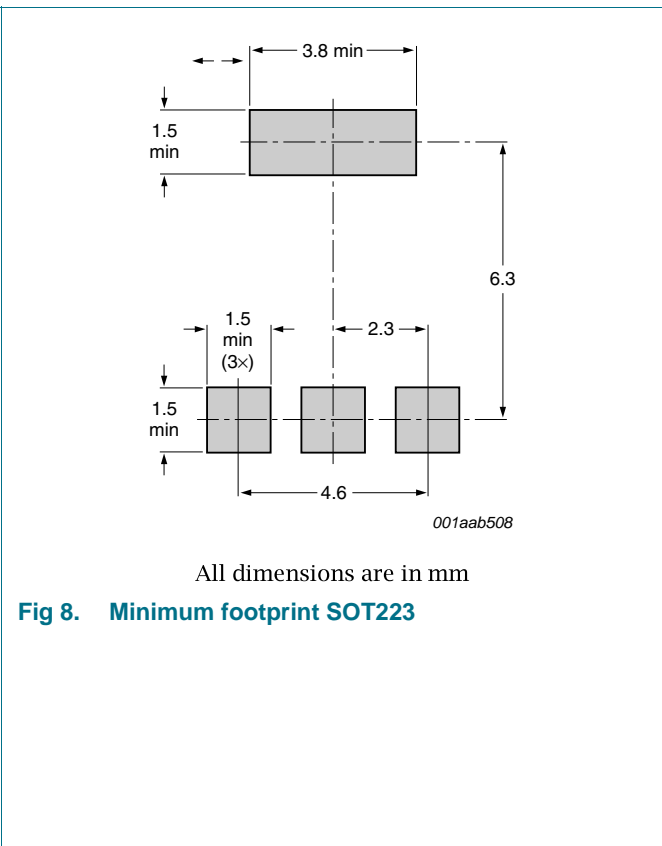
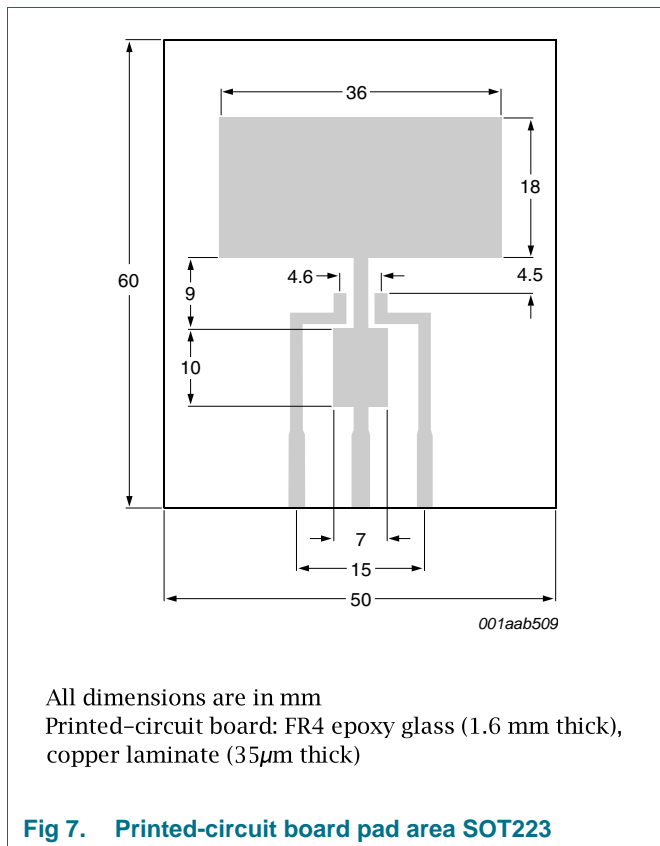

Fig 6. Test circuit for inductive and resistive loads with conditions equivalent to IEC 61000-4-5

5. Thermal characteristics

Table 5. Thermal characteristics

Symbol	Parameter	Conditions	Min	Typ	Max	Unit
$R_{th(j-sp)}$	thermal resistance from junction to solder point	full cycle with heatsink compound; see Figure 9	-	-	15	K/W
$R_{th(j-a)}$	thermal resistance from junction to ambient	full cycle; printed-circuit board mounted for pad area; see Figure 7	-	70	-	K/W
		full cycle; printed-circuit board mounted for minimum footprint; see Figure 8	-	156	-	K/W



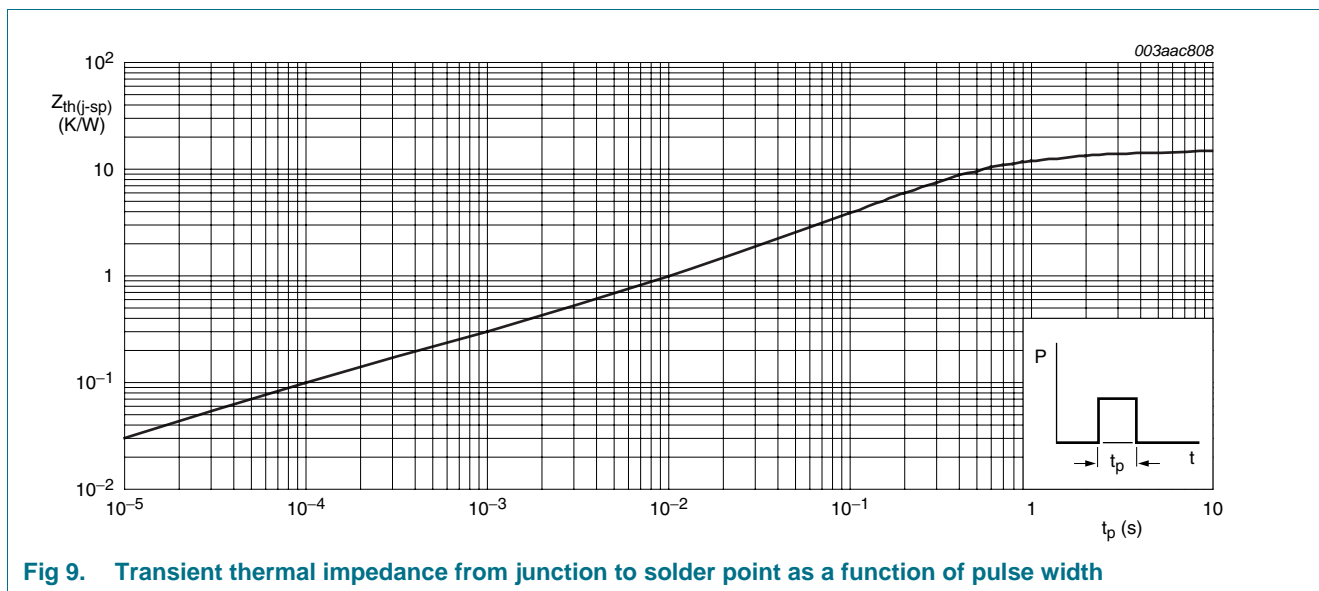
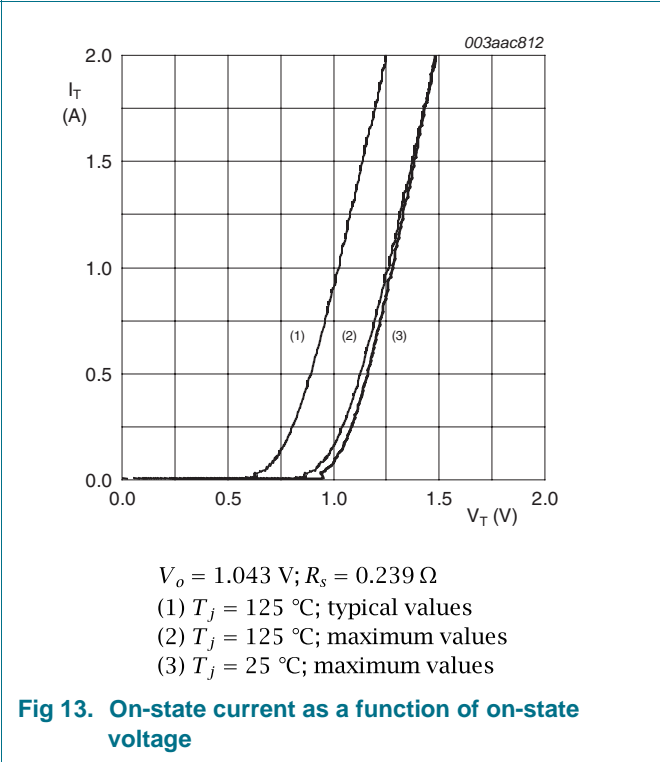
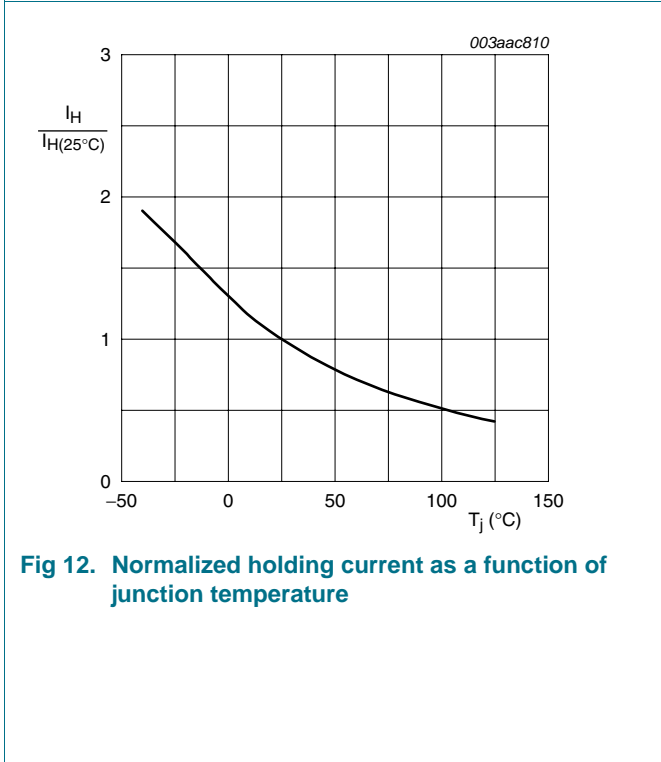
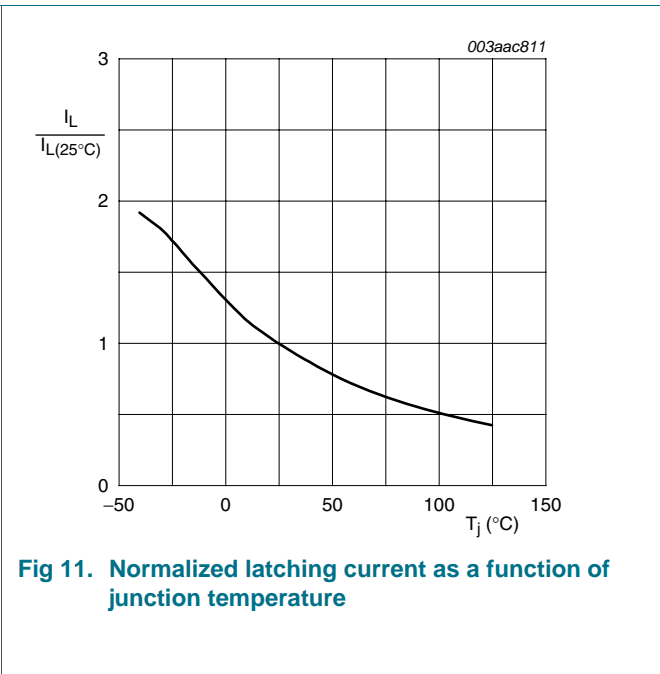
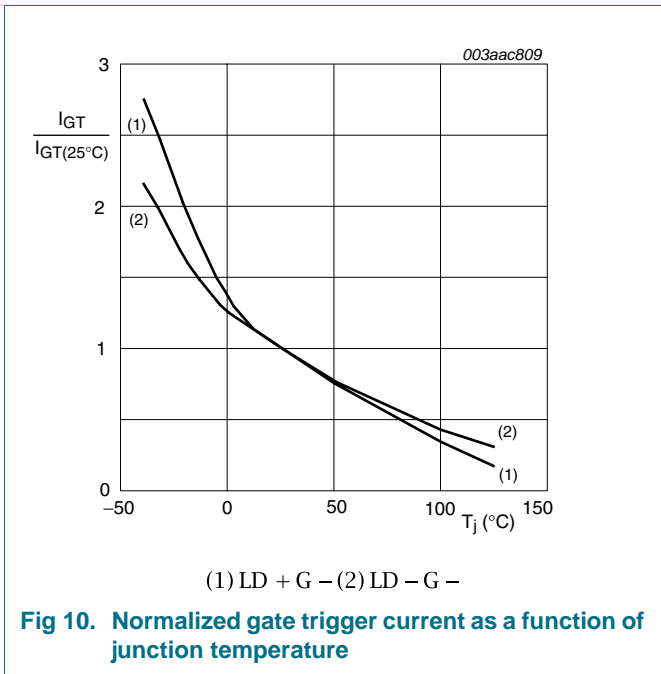

Fig 9. Transient thermal impedance from junction to solder point as a function of pulse width

6. Characteristics

Table 6. Characteristics

Symbol	Parameter	Conditions	Min	Typ	Max	Unit
I _{GT}	gate trigger current	V _D = 12 V; I _T = 100 mA; LD+ G-; T _j = 25 °C; see Figure 10	1	-	10	mA
		V _D = 12 V; I _T = 100 mA; LD- G-; T _j = 25 °C	1	-	10	mA
I _L	latching current	V _D = 12 V; I _G = 12 mA; T _j = 25 °C; see Figure 11	-	-	30	mA
I _H	holding current	V _D = 12 V; T _j = 25 °C; see Figure 12	-	9	25	mA
V _T	on-state voltage	I _T = 1.1 A; see Figure 13	-	-	1.3	V
V _{GT}	gate trigger voltage	V _D = 600 V; I _T = 100 mA; T _j ≤ 125 °C	0.15	-	-	V
		V _D = 600 V; I _T = 100 mA; T _j = 25 °C	-	-	1	V
I _D	off-state current	V _D = 600 V; T _j ≤ 125 °C	-	-	0.2	mA
		V _D = 600 V; T _j ≤ 25 °C	-	-	2	µA
dV _D /dt	rate of rise of off-state voltage	V _{DM} = 402 V; T _j = 125 °C; gate open circuit; see Figure 14	1000	-	-	V/µs
dl _{com} /dt	rate of change of commutating current	V _D = 400 V; T _j = 125 °C; I _{T(RMS)} = 1 A; dV _{com} /dt = 15 V/µs; gate open circuit; see Figure 15 and 16	0.3	-	-	A/ms
V _{CL}	clamping voltage	I _{CL} = 100 mA; t _p = 1 ms; T _j ≤ 125 °C; see Figure 17	650	-	-	V



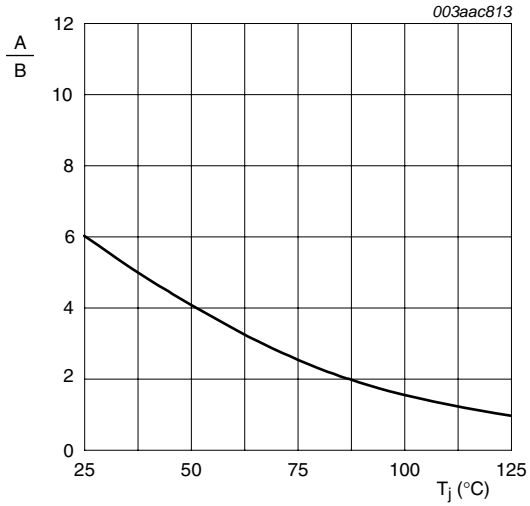

A is dV_D/dt at condition T_j °C
 B is dV_D/dt at condition $T_j = 125$ °C

Fig 14. Normalized rate of rise of off-state voltage as a function of junction temperature

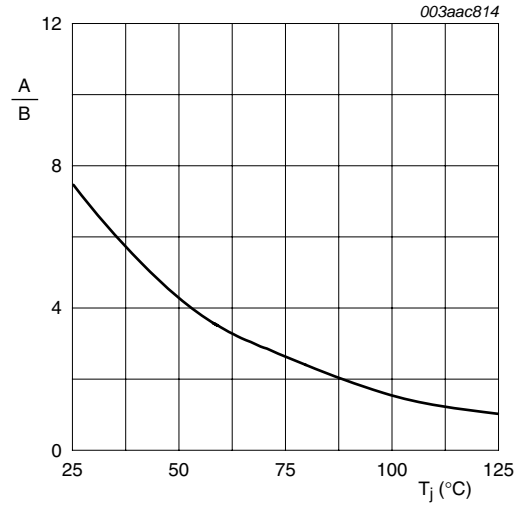

A is dI_{com}/dt at condition T_j °C
 B is dI_{com}/dt at $T_j = 125$ °C $V_D = 400$ V

Fig 15. Normalized critical rate of rise of commutating current as a function of junction temperature

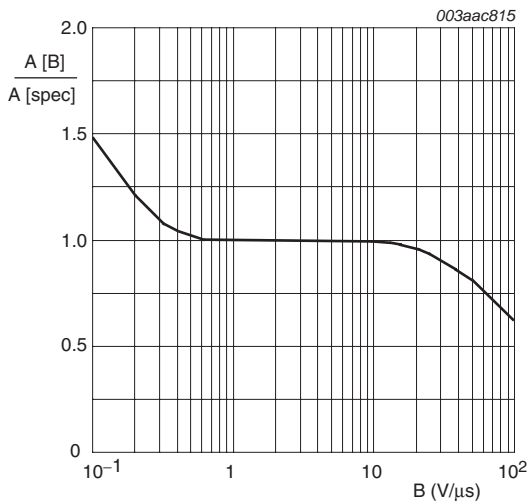

A[B] is $\frac{dI_{com}}{dt}$ at condition B, $\frac{dV_{com}}{dt}$
 A[spec] is the specified data sheet value of $\frac{dI_{com}}{dt}$

Fig 16. Normalized critical rate of change of commutating current as a function of critical rate of change of commutating voltage; minimum values

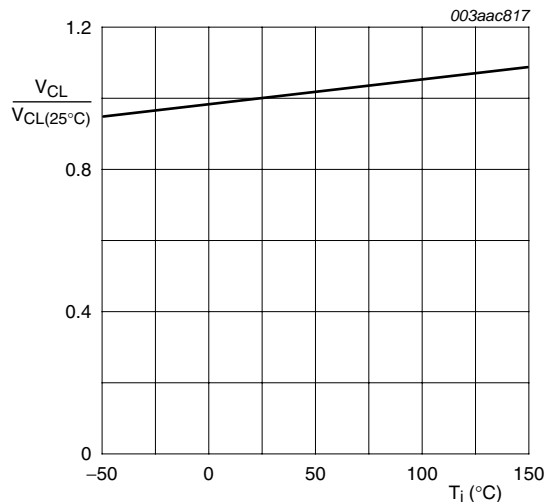

Fig 17. Normalized clamping voltage (upper limit) as a function of junction temperature; minimum values

7. Package outline

Plastic surface-mounted package with increased heatsink; 4 leads

SOT223

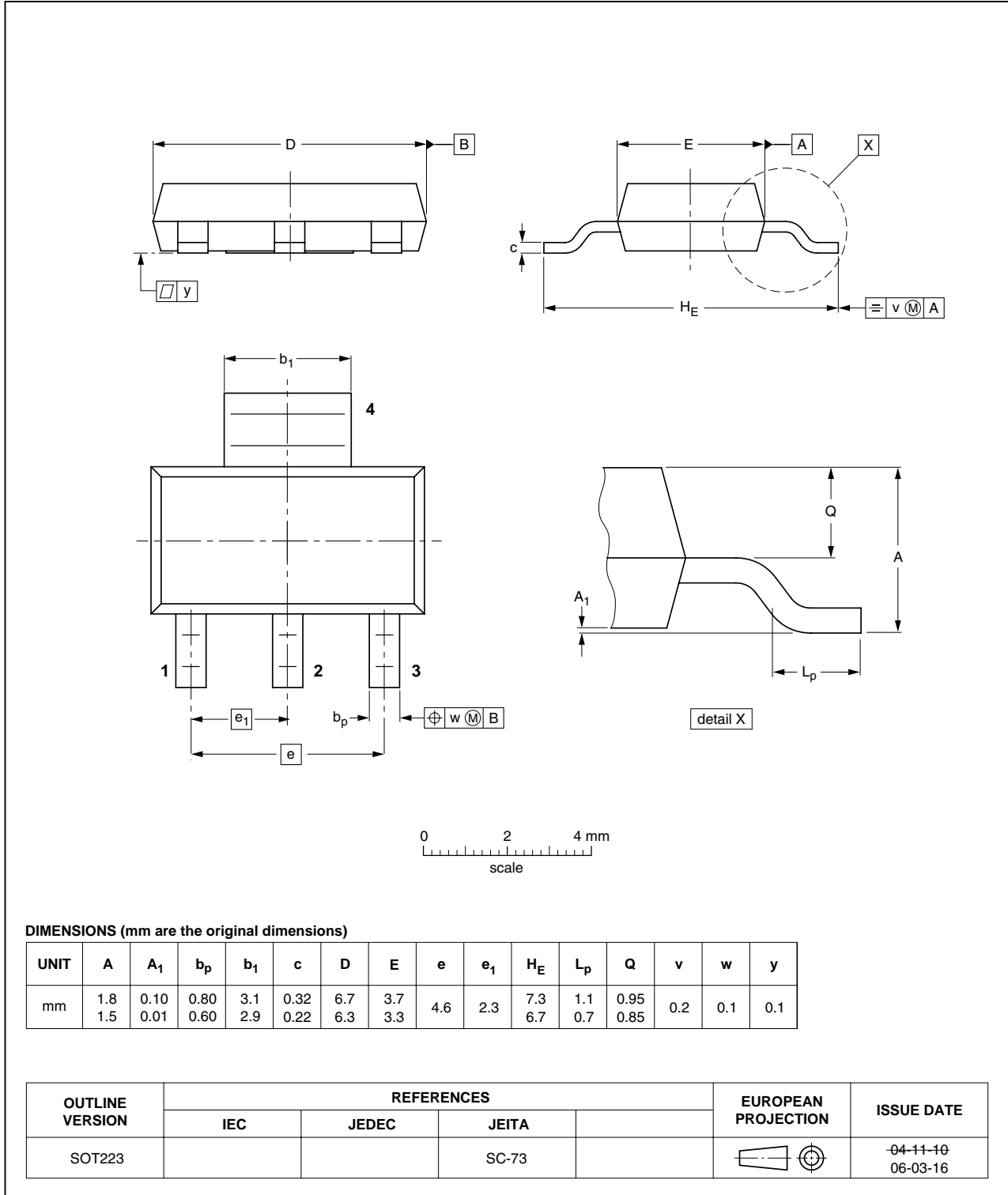

Fig 18. Package outline SOT223 (SC-73)

8. Revision history

Table 7. Revision history

Document ID	Release date	Data sheet status	Change notice	Supersedes
ACT108W-600E_3	20091021	Product data sheet	-	ACT108W-600E_2
Modifications:	• Various changes to content.			
ACT108W-600E_2	20090526	Product data sheet	-	ACT108W-600E_1
ACT108W-600E_1	20090429	Product data sheet	-	-

9. Legal information

9.1 Data sheet status

Document status ^{[1][2]}	Product status ^[3]	Definition
Objective [short] data sheet	Development	This document contains data from the objective specification for product development.
Preliminary [short] data sheet	Qualification	This document contains data from the preliminary specification.
Product [short] data sheet	Production	This document contains the product specification.

[1] Please consult the most recently issued document before initiating or completing a design.

[2] The term 'short data sheet' is explained in section "Definitions".

[3] The product status of device(s) described in this document may have changed since this document was published and may differ in case of multiple devices. The latest product status information is available on the Internet at URL <http://www.nxp.com>.

9.2 Definitions

Draft — The document is a draft version only. The content is still under internal review and subject to formal approval, which may result in modifications or additions. NXP Semiconductors does not give any representations or warranties as to the accuracy or completeness of information included herein and shall have no liability for the consequences of use of such information.

Short data sheet — A short data sheet is an extract from a full data sheet with the same product type number(s) and title. A short data sheet is intended for quick reference only and should not be relied upon to contain detailed and full information. For detailed and full information see the relevant full data sheet, which is available on request via the local NXP Semiconductors sales office. In case of any inconsistency or conflict with the short data sheet, the full data sheet shall prevail.

9.3 Disclaimers

General — Information in this document is believed to be accurate and reliable. However, NXP Semiconductors does not give any representations or warranties, expressed or implied, as to the accuracy or completeness of such information and shall have no liability for the consequences of use of such information.

Right to make changes — NXP Semiconductors reserves the right to make changes to information published in this document, including without limitation specifications and product descriptions, at any time and without notice. This document supersedes and replaces all information supplied prior to the publication hereof.

Suitability for use — NXP Semiconductors products are not designed, authorized or warranted to be suitable for use in medical, military, aircraft, space or life support equipment, nor in applications where failure or malfunction of an NXP Semiconductors product can reasonably be expected to result in personal injury, death or severe property or environmental damage. NXP Semiconductors accepts no liability for inclusion and/or use of NXP Semiconductors products in such equipment or applications and therefore such inclusion and/or use is at the customer's own risk.

Applications — Applications that are described herein for any of these products are for illustrative purposes only. NXP Semiconductors makes no representation or warranty that such applications will be suitable for the specified use without further testing or modification.

Quick reference data — The Quick reference data is an extract of the product data given in the Limiting values and Characteristics sections of this document, and as such is not complete, exhaustive or legally binding.

Limiting values — Stress above one or more limiting values (as defined in the Absolute Maximum Ratings System of IEC 60134) may cause permanent damage to the device. Limiting values are stress ratings only and operation of the device at these or any other conditions above those given in the Characteristics sections of this document is not implied. Exposure to limiting values for extended periods may affect device reliability.

Terms and conditions of sale — NXP Semiconductors products are sold subject to the general terms and conditions of commercial sale, as published at <http://www.nxp.com/profile/terms>, including those pertaining to warranty, intellectual property rights infringement and limitation of liability, unless explicitly otherwise agreed to in writing by NXP Semiconductors. In case of any inconsistency or conflict between information in this document and such terms and conditions, the latter will prevail.

No offer to sell or license — Nothing in this document may be interpreted or construed as an offer to sell products that is open for acceptance or the grant, conveyance or implication of any license under any copyrights, patents or other industrial or intellectual property rights.

Export control — This document as well as the item(s) described herein may be subject to export control regulations. Export might require a prior authorization from national authorities.

9.4 Trademarks

Notice: All referenced brands, product names, service names and trademarks are the property of their respective owners.

10. Contact information

For more information, please visit: <http://www.nxp.com>

For sales office addresses, please send an email to: salesaddresses@nxp.com

11. Contents

1 Product profile1

1.1 General description1

1.2 Features and benefits1

1.3 Applications1

1.4 Quick reference data1

2 Pinning information2

3 Ordering information2

4 Limiting values3

5 Thermal characteristics6

6 Characteristics7

7 Package outline10

8 Revision history11

9 Legal information12

9.1 Data sheet status12

9.2 Definitions12

9.3 Disclaimers12

9.4 Trademarks12

10 Contact information12

Please be aware that important notices concerning this document and the product(s) described herein, have been included in section 'Legal information'.



© NXP B.V. 2009.

All rights reserved.

For more information, please visit: <http://www.nxp.com>

For sales office addresses, please send an email to: salesaddresses@nxp.com

Date of release: 21 October 2009

Document identifier: ACT108W-600E_3